

Linear

TIA 26 Asymmetric A030 (30W) Fixture Guide

KKDÖ

Indoor | Surface | Output up to 3630lm/m (1106lm/ft)



Key applications

- ✓ Ceiling
- ✓ Direct lighting
- ✓ Downlighting
- ✓ Flood lighting
- ✓ Interior
- ✓ Retail display
- ✓ Wall grazing
- ✓ Wallwashing

Key features

- ✓ A-line (High Efficacy)
- ✓ Asymmetric lens
- ✓ Custom lengths
- ✓ Constant Voltage (CV)
- ✓ Diffusion: homogenous
- ✓ Direct view
- ✓ High lumen efficacy
- ✓ IP40 dry area
- ✓ Lens options

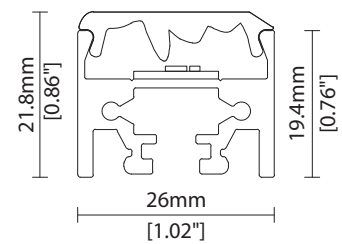

MOUNTING METHODS



KKCP-11 Concealed clip



KKBK-25 Adjustable bracket

Linear

TIA 26 Asymmetric A030 (30W)

Specification sheet



Dimensions	H21.8/W26/L96-1019mm (H0.9/W1.02/L3.8-40.1in)
PCB Cut-point	38.46mm increment/1019mm max (1.51in increment/78.74in max)
LED Pitch	4.8mm - 208LED/m (0.19in - 64LED/ft)
Chip	A-line
Cover/Optics	KKLN-A1 Asymmetric lens (Beam tilt 25°, Beam angle 50°)
CCT	A-line: 2700K/3000K/3500K/4000K
LED binning	A-line: 3-step MacAdam ellipse
CRI	94
Lifetime	50,000 hours @ 25°C (50,000 hours @ 77°F)
Operating temp	T _a = -25 to 50°C (T _c max = 76.1°C) T _a = -13 to 104°F (T _c max = 169°F)
IP Rating	IP40
Finish	Silver anodised
Mounting	Surface mounting via concealed clips or brackets
Power feed	Non Sheathed tail
Control	0-10V/1-10V/DMX/DALI



LED Grading Key

Exclusive Grade *KKDC tuned CCT range
A-line* 3-step CCT range
 KKDC highest lumen efficacy LED

Power consumption	Supply voltage	Supply current
30W/m (9.14W/ft)	24V DC	1.25A/m (0.38A/ft)

Performance Data (3000K)

	R1	R2	R3	R4	R5	R6	R7	R8	R9	R10	R11	R12	R13	R14
A-line	95	96	95	94	92	92	97	91	78	88	93	67	95	97

KKLN-A1		CRI	R9	Rf	Rg
A-line	3630lm/m (1106lm/ft) 121lm/w	94	78	-	-

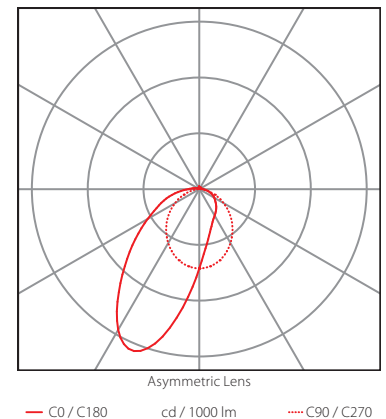
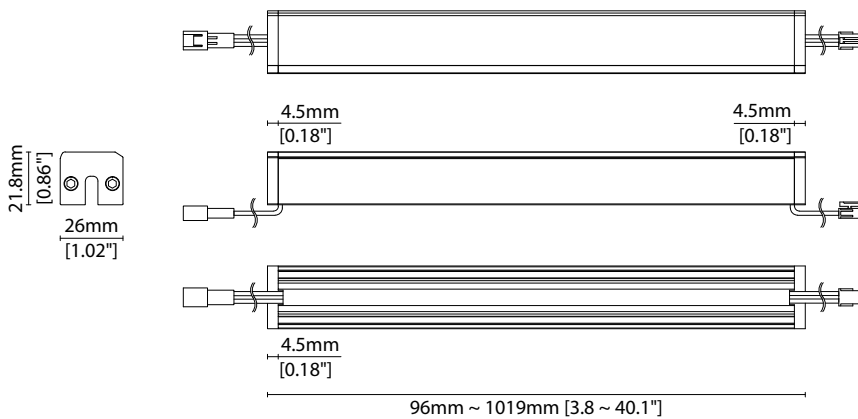

Data derived from independent UKAS/IESNA LM-79-08 accredited testing of production samples.

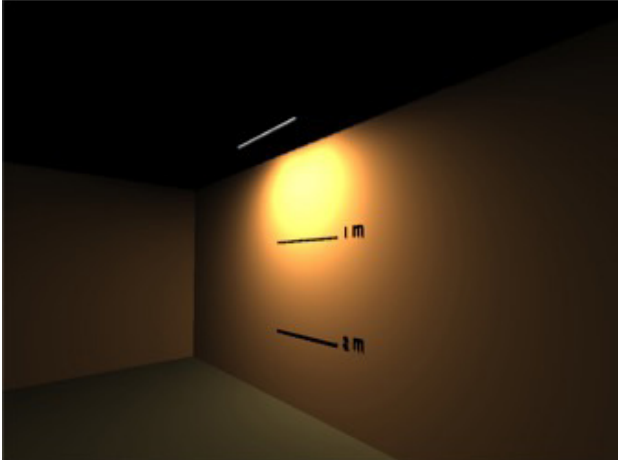

0.5M between light and wall

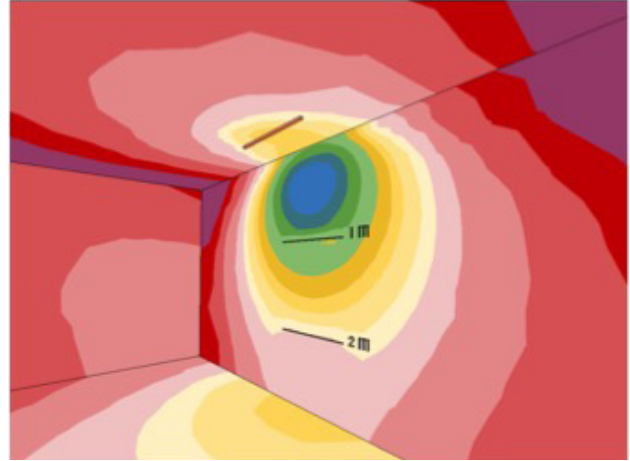

0.5M between light and wall (Psuedo color)

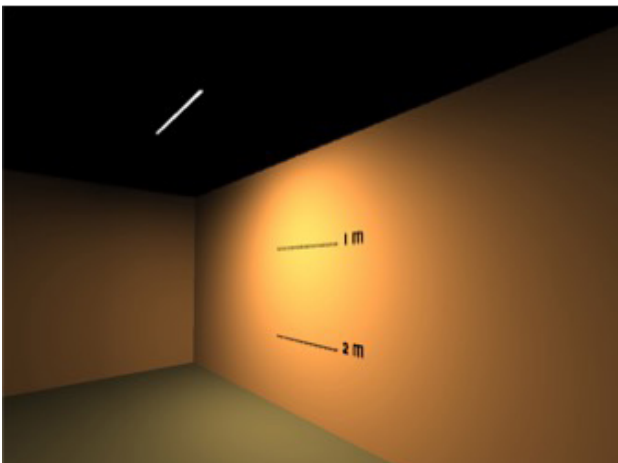

1M between light and wall

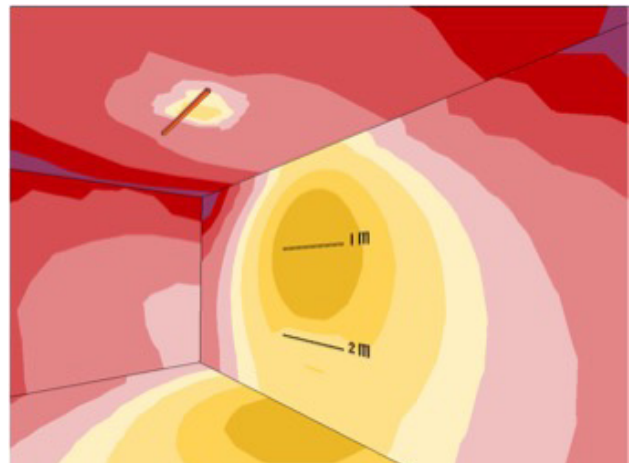

1M between light and wall (Psuedo color)

Distance between wall and light	Light reaching height (based on wall)
0.5M	1M
1.1M	1.5M
1.3M	2M

TIA 26 Asymmetric A030 (30W) Code Table



FIXTURE

Model	Finish	Cover/Lens ¹	Grade ²	LED	Colour (CCT)	Length Availability ³	IP	Cable Length	Power Feed	Input													
TIA 26 Asymmetric	TY	Silver Anodised	SA	KKLN-A1 (Asymmetric lens)	A1	A-	A	A030	030	2700K	27	m	L96-1019mm 38.46mm increments	IP40	40	300mm (11.81in)	0300	Single no sheath tail	S00X	DC 24V	g		
										3000K	30							i	L3.8-40.1in 1.51in increments			Double no sheath tail	D00X
										3500K	35											Single no sheath IP20 connector	S20X
										4000K	40											Double no sheath IP20 connector	D20X
(Specify length code OR total run length)																							

¹ Refer to **Cover/Lens options** on **Options** page

² Refer to **LED Grading Key** on **Specification sheet** page

³ Refer to **Length Availability List** or enter total run length instead of length code

Code Example:

TY	-	SA	-	A1	-	A	-	030	-	30	-	m	519	-	40	-	0300	-	S00X	-	g
TIA 26 Asymmetric		Silver Anodised		KKLN-A1		A-		A030		3000K		519mm		IP40		300mm (11.81in)		Single no sheath tail		DC 24V	

ACCESSORIES

Mounting Accessories

KKCP-11	Concealed Clip
KKBK-25	Adjustable bracket

* Refer to **Mounting accessories** on **Accessories** pages

Connection Accessories

KKCN-01	2 PIN male & female 50mm/1.97" pair
KKCN-03	2 PIN male & female 300mm/11.81" pair
KKCN-06	2 PIN 300mm/11.81" extension lead

* Refer to **Power feed** on **Accessories** pages

PSU/Driver

0-10V/1-10V/DALI/DMX

* Refer to **Driver/PSU Options** page for details or provide requirement and KKDC to offer the suitable option

TIA 26 Asymmetric A030 (30W)

Length Availability List



Length Code		Fixture Length ¹		LED Strip ²		End Cap Dimension		Wattage (W)	Output (lm) 3000K (Test Data)
Metric	Imperial(US)	Metric	Imperial(US)	Metric	Imperial(US)	Metric	Imperial(US)		
m0096	i0004	96mm	3.78in	77mm	3.03in	9mm	0.35in	2.31	279
m0134	i0005	134mm	5.29in	115mm	4.54in	9mm	0.35in	3.46	419
m0173	i0007	173mm	6.80in	154mm	6.06in	9mm	0.35in	4.62	558
m0211	i0008	211mm	8.32in	192mm	7.57in	9mm	0.35in	5.77	698
m0250	i0010	250mm	9.83in	231mm	9.09in	9mm	0.35in	6.92	838
m0288	i0011	288mm	11.35in	269mm	10.60in	9mm	0.35in	8.08	977
m0327	i0013	327mm	12.86in	308mm	12.11in	9mm	0.35in	9.23	1117
m0365	i0014	365mm	14.38in	346mm	13.63in	9mm	0.35in	10.38	1257
m0404	i0016	404mm	15.89in	385mm	15.14in	9mm	0.35in	11.54	1396
m0442	i0017	442mm	17.40in	423mm	16.66in	9mm	0.35in	12.69	1536
m0481	i0019	481mm	18.92in	462mm	18.17in	9mm	0.35in	13.85	1675
m0519	i0020	519mm	20.43in	500mm	19.69in	9mm	0.35in	15.00	1815
m0557	i0022	557mm	21.95in	538mm	21.20in	9mm	0.35in	16.15	1955
m0596	i0023	596mm	23.46in	577mm	22.71in	9mm	0.35in	17.31	2094
m0634	i0025	634mm	24.98in	615mm	24.23in	9mm	0.35in	18.46	2234
m0673	i0026	673mm	26.49in	654mm	25.74in	9mm	0.35in	19.62	2373
m0711	i0028	711mm	28.00in	692mm	27.26in	9mm	0.35in	20.77	2513
m0750	i0030	750mm	29.52in	731mm	28.77in	9mm	0.35in	21.92	2653
m0788	i0031	788mm	31.03in	769mm	30.28in	9mm	0.35in	23.08	2792
m0827	i0033	827mm	32.55in	808mm	31.80in	9mm	0.35in	24.23	2932
m0865	i0034	865mm	34.06in	846mm	33.31in	9mm	0.35in	25.38	3072
m0904	i0036	904mm	35.58in	885mm	34.83in	9mm	0.35in	26.54	3211
m0942	i0037	942mm	37.09in	923mm	36.34in	9mm	0.35in	27.69	3351
m0981	i0039	981mm	38.60in	962mm	37.86in	9mm	0.35in	28.85	3490
m1019	i0040	1019mm	40.12in	1000mm	39.37in	9mm	0.35in	30.00	3630

¹ Actual total overall length of light fixture (LED strip + end caps + void/wire hole)

² Actual length of PCB strip

³ Actual length of 2x end caps

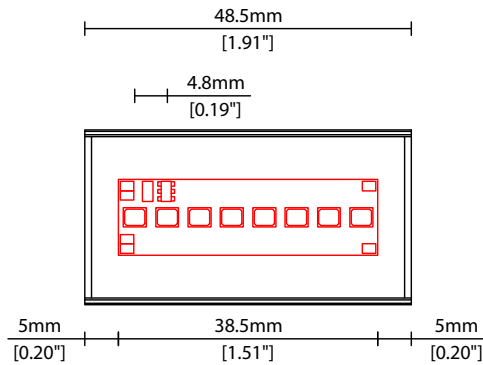

Linear

TIA 26 Asymmetric A030 (30W) Options

KKDC

COVER/LENS OPTIONS

* Options are an integral part of the fixture ordering codes. Please refer to **Code Table** pages.

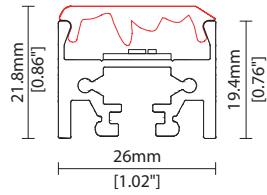

A1 KKLN-A1 Asymmetric
W26/H21.8mm (W1.02/H0.86")

Key

Control Gear Power supply, sub-controllers & control systems
JB Junction box / cable connection

POWER FEED OPTIONS

* Options are an integral part of the fixture ordering codes. Please refer to **Code Table** pages.

0300 S00X 300mm (11.81") Single no sheath tail

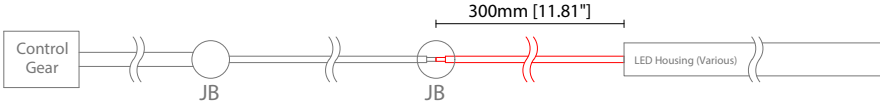

0300 D00X 300mm (11.81") Double no sheath tail

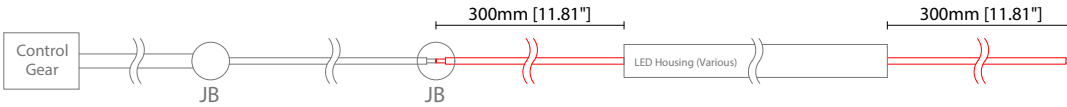

0300 S20X 300mm (11.81") Single no sheath IP20 connector

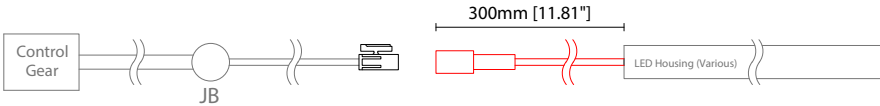

0300 D20X 300mm (11.81") Double no sheath IP20 connector

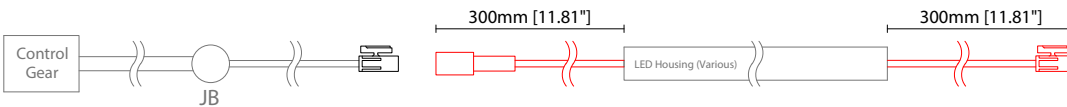

2 Pin Female Connector

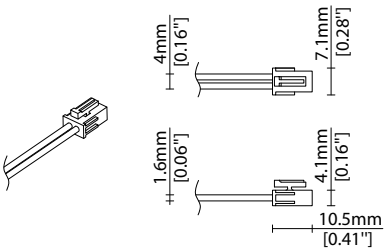

2 Pin Male Connector

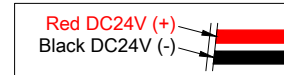
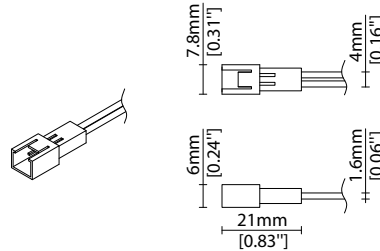

Key

- Control Gear Power supply, sub-controllers & control systems
- JB Junction box / cable connection

MOUNTING ACCESSORIES

Note: Accessories are to be ordered separately with corresponding code shown below.

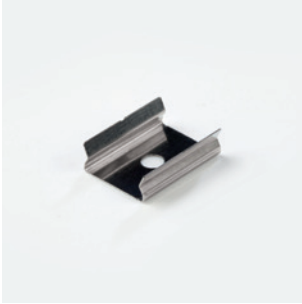

KKCP-11

Concealed clip
(allow 3 per metre/40in)
S/Steel finish
L20/W26/H22.1mm
(L0.79/W10.2/H0.87")

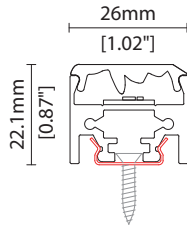

KKBK-25

Adjustable bracket
(allow 2 per metre/40in)
Anodised aluminium finish
L30/W40/H29.6mm
(L1.18/W1.57/H1.16")

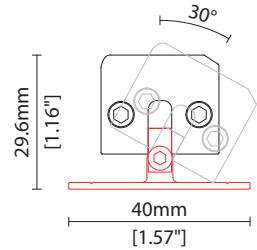

POWER FEED

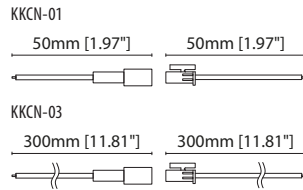
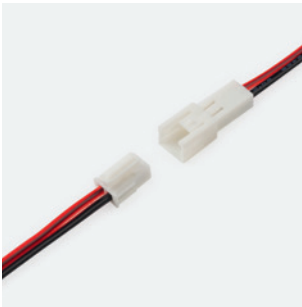

KKCN-01 50mm (1.97in) pair
KKCN-03 300mm (11.81in) pair
2 PIN male + female connector set

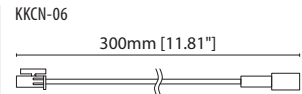

KKCN-06
2 PIN 300mm (11.81in) extension lead

KKDC CONTROL



IP20
Plastic housing
L170/W59/H29mm
(L6.69/W2.32/H1.14in)

KKDM-06 1-10V
visDIM dimmable sub-controller
(4 x 8A max @ 12-36V)



IP20
Plastic housing
L170/W53.4/H28mm
(L6.69/W2.10/H1.10in)

KKSC-05 DMX
visDIM dimmable sub-controller
(4 x 5A max @ 12-36V)



IP20
Plastic housing
L170/W59/H29mm
(L6.69/W2.32/H1.14in)

KKDL-02 DALI
visDIM dimmable sub-controller
(4 x 8A max @ 12-36V)



IP20
Plastic housing
L166/W53.4/H23mm
(L6.54/W2.10/H0.91in)

KKDL-03 DALI
visDIM dimmable sub-controller
(4 x 5A max @ 12-36V)

AVAILABLE PSU OPTIONS

Control Mode	PSU (Order Code)	Input Voltage AC	Output Voltage DC	Rated Output Current	Rated Power	Dim %	IP Rating
Switched	CEN-60-24	90-295V	24V	2.5A	60W	-	IP67
	HLG-60H-24	90-305V	24V	2.5A	60W	-	IP67
	HLG-100H-24	90-305V	24V	4.0A	100W	-	IP67
	HLG-150H-24	90-305V	24V	6.3A	150W	-	IP67
	HLG-240H-24	90-305V	24V	10A	240W	-	IP67
0-10V (1-10V)	PWM-40-24	90-305V	24V	1.67A	40W	100-0.15 (100-10)	IP67
	PWM-60-24	90-305V	24V	2.5A	60W	100-0.15 (100-10)	IP67
	PWM-90-24	90-305V	24V	3.67A	90W	100-0.15 (100-10)	IP67
	PWM-120-24	90-305V	24V	5.0A	120W	100-0.15 (100-10)	IP67
DALI	LIN100A1	120-277V	24V	1A per channel	100W	100-0.1	IP66/IP40
DMX RGB	LIN100A1	120-277V	24V	1.33A per channel	100W	100-0.1	IP66/IP40
DMX RGBW	LIN100A1	120-277A	24V	1A per channel	100W	100-0.1	IP66/IP40

Flicker Free Options - Combination of PSU+ sub-controller

Control Mode	PSU (Order Code)	Sub-controller (Order Code)	Input Voltage AC	Output Voltage DC	Rated Output Current	Rated Power	Dim %	IP Rating PSU/ Sub-controller
0-10V or 1-10V	CEN-60-24	KKDM-06	90-295V	24V	2.5A	60W	100-0.9	IP67/IP20
	HLG-60H-24	KKDM-06	90-295V	24V	2.5A	60W	100-0.9	IP67/IP20
	HLG-100H-24	KKDM-06	90-295V	24V	4.0A	100W	100-0.9	IP67/IP20
	HLG-150H-24	KKDM-06	90-295V	24V	6.3A	150W	100-0.9	IP67/IP20
	HLG-240H-24	KKDM-06	90-295V	24V	10.0A	240W	100-0.9	IP67/IP20
DALI	CEN-60-24	KKDL-02/03	90-295V	24V	2.5A	60W	100-0.1	IP67/IP20
	HLG-60H-24	KKDL-02/03	90-305V	24V	2.5A	60W	100-0.1	IP67/IP20
	HLG-100H-24	KKDL-02/03	90-305V	24V	4.0A	100W	100-0.1	IP67/IP20
	HLG-150H-24	KKDL-02/03	90-305V	24V	6.3A	150W	100-0.1	IP67/IP20
	HLG-240H-24	KKDL-02/03	90-305V	24V	10.0A	240W	100-0.1	IP67/IP20
DMX RGB	CEN-60-24	KKSC-05	90-295V	24V	2.5A	60W	100-0.9	IP67/IP20
	HLG-60H-24	KKSC-05	90-305V	24V	2.5A	60W	100-0.9	IP67/IP20
	HLG-100H-24	KKSC-05	90-305V	24V	4A	100W	100-0.9	IP67/IP20
	HLG-150H-24	KKSC-05	90-305V	24V	6.3A	150W	100-0.9	IP67/IP20
	HLG-240H-24	KKSC-05	90-305V	24V	10.0A	240W	100-0.9	IP67/IP20

¹ The items shown above cover the most frequently used specification but does not exhaust the possible options

² PSU and/or driver can be chosen from the table, or KKDC may recommend the best option upon receipt of the controls requirement and installation environment

³ Electrical shop drawing will include detailed information of PSU and relevant control drivers

⁴ Cut sheets are available on the controls section of www.kkdc.lighting or upon request